



1. 使用環境條件

Apply Environmental Condition :

No.	項目 item	規格 standard
1-1	保存溫度 Storage Temperature Range	-20°C ~ 60°C
1-2	操作溫度 Operating Temperature Range	-10°C ~ 50°C
1-3	操作電壓 Operating Voltage Range	6.0V~7.4V

2. 測試環境

Standard Test Environment :

2-1	測試環境 Standard Test Environment	每一个检查必须是正常的温度和湿度进行测量，温度 $25 \pm 5^\circ\text{C}$ ，相对湿度 $65 \pm 10\%$ ，在按照本规范的标准测试条件下判断特征。 Every characteristic of the inspect must be normal temperature and humidity carry out the test , temperature $25 \pm 5^\circ\text{C}$ and relative humidity $65 \pm 10\%$ of judgment made in accordance with this specification standard testing conditions.
-----	-----------------------------------	--

3. 外觀檢查

Appearance Inspection :

No.	項目 item	規格 standard
3-1	外觀尺寸 Outline Drawing	尺寸见附件 Dimension see the attachment
3-2	外觀 Appearance	无损坏，不允许影响功能 No damage which affects functions allowed



4. 電氣特性

Electrical Specification (Function of the Performance) :

No.	項目 item	6.0V	7.4V
4-1	空載轉速 Operating speed (at no load)	0.07 sec/60°	0.06 sec/60°
4-2	空載電流(低速到快速) Running current at no load(Slow to Fast)	120~520 mA	120~550 mA
4-3	停止扭力 Stall torque (at locked)	9.0 kg-cm	12.0 kg-cm
4-4	停止電流 Stall current (at locked)	3200 mA	3750 mA
4-5	待機電流 Idle current (at stopped)	29 mA	37 mA

注：項目 4-2 定义平均值时，伺服器无负荷运行

Note: Item 4-2 definition is average value when the servo running with no load

5. 機械特性

Mechanical Specification :

No.	項目 item	規格 standard
5-1	外觀尺寸 Overall Dimensions	见附件 See the drawing
5-2	機構極限角度 Limit angle	180° ± 10°
5-3	重量 Weight	48 ± 1g
5-4	導線規格 Connector wire gauge	# 28 AWG 0.08* 60
5-5	導線長度 Connector wire length	80 ± 5 mm
5-6	舵片規格 Horn gear spline	ψ5.8*25T
5-7	舵片種類 Horn type	电房专用金属摆臂 Metal arm (electricity room dedicated)
5-8	減速比 Reduction ratio	1/141
5-9	齒輪材質 Materials of the gear	鋁鍍鈦齒輪 Titanium & 7075 Alu



Product Name
数字伺服器 Digital Servo

Model No.
EP-XYT

Version
V1

Page
2/3

6. 控制特性

Control Specification :

No.	項目	規格
6-1	控制系統 Control system	脈波寬度調變 Pulse Width Modification
6-2	放大器種類 Amplifier type	333Hz 數字控制器 333Hz Digital Controller
6-3	操作角度 Operating travel	90° (在 1500→2000 μ sec)
6-4	中立位置 Neutral position	1500 μ sec
6-5	脈波訊號虛位 Dead band width	2 μ sec
6-6	旋轉方向 Rotating direction	逆時針 (在 1500→2000 μ sec) Counterclockwise (when 1500→2000 μ sec)
6-7	脈波寬度範圍 Pulse width range	800→2200 μ sec
6-8	可作動角度範圍 Maximum travel	大約 125° (在 800→2200 μ sec) Approx 125° (when 800→2200 μ sec)

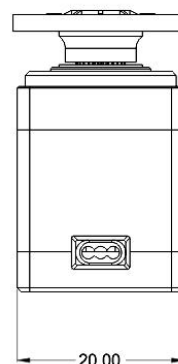
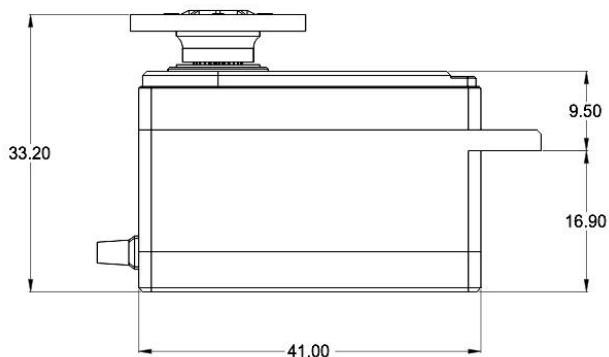
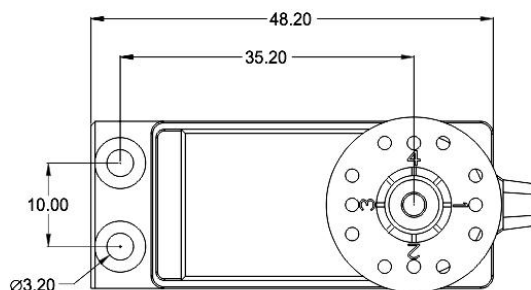

Product Name
數字伺服器 Digital Servo

Model No.
EP-XYT

Version
V1

Page
3/3